

# Candy

## Typ B

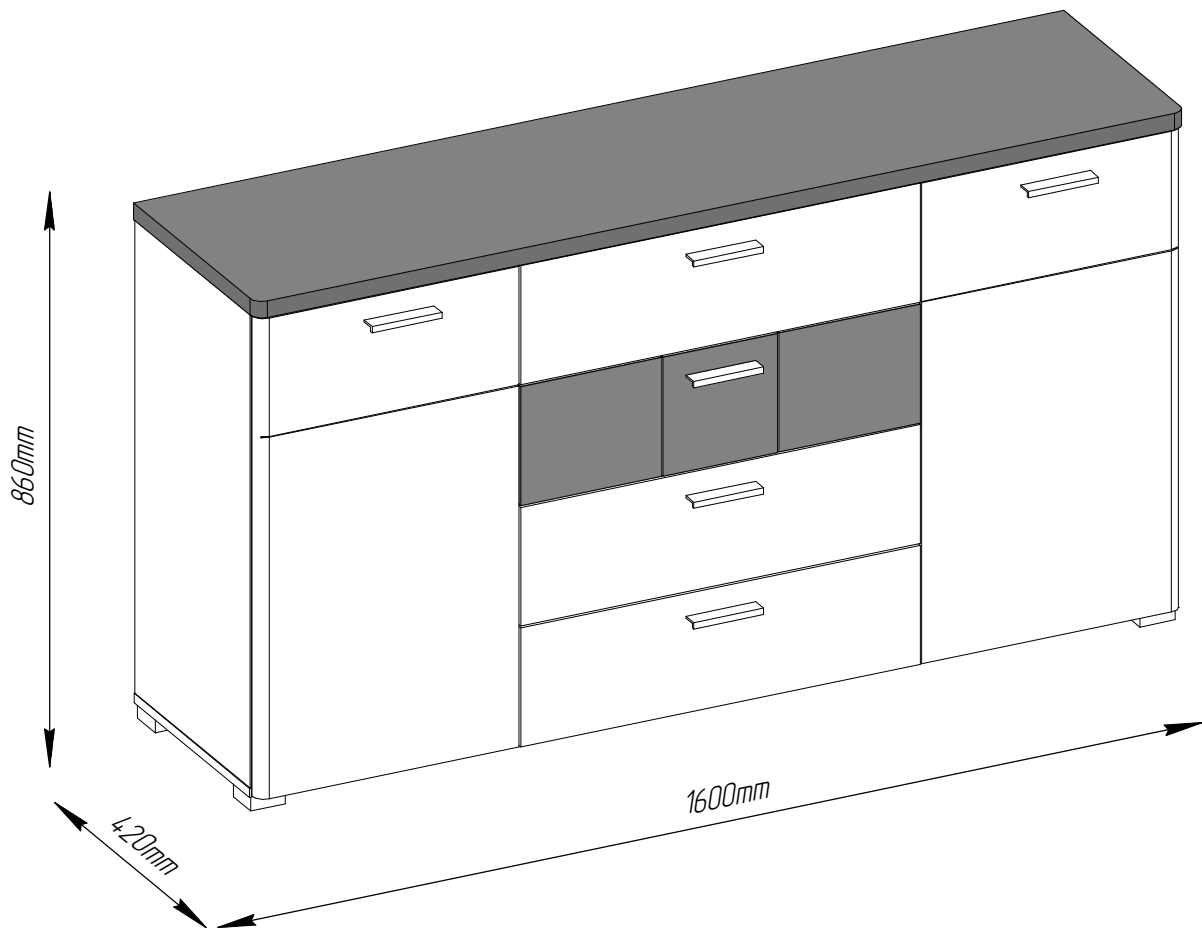

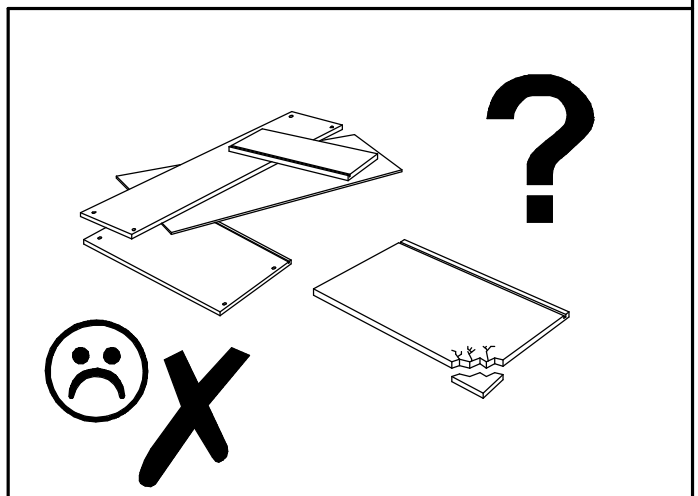

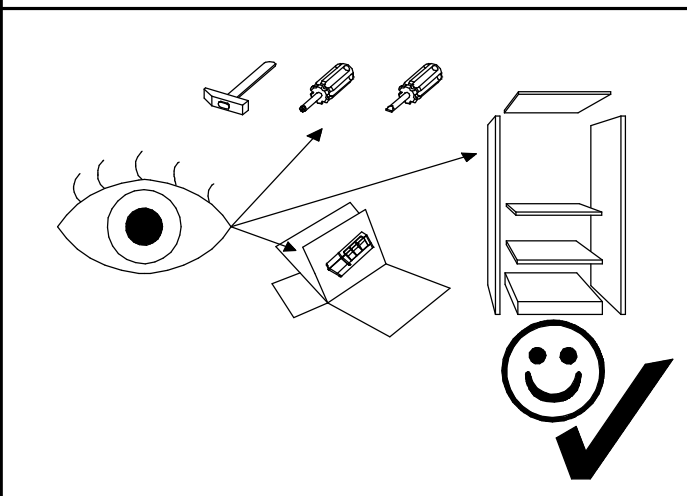
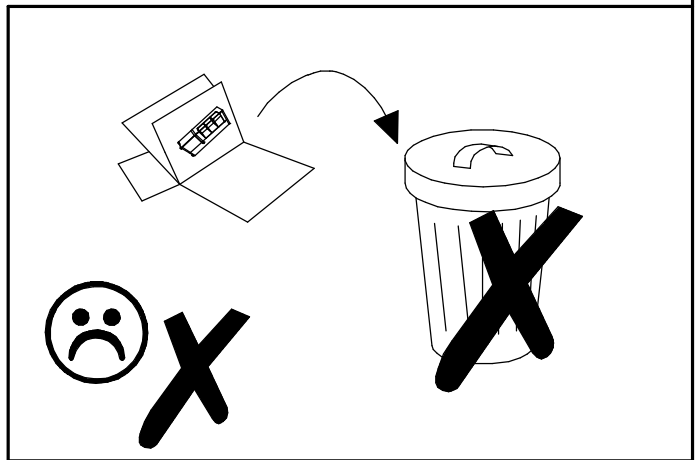
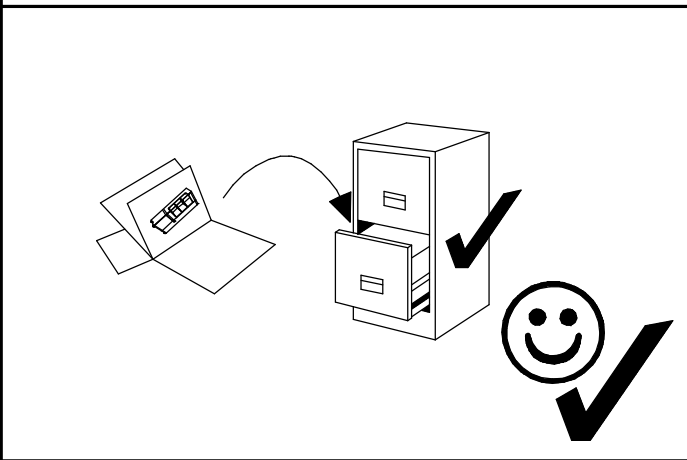
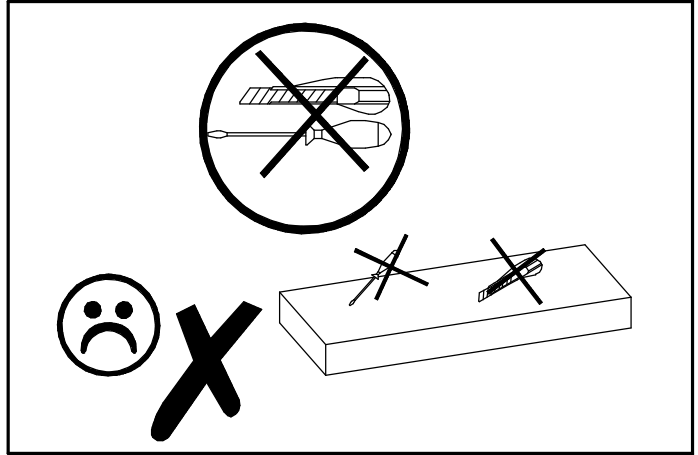
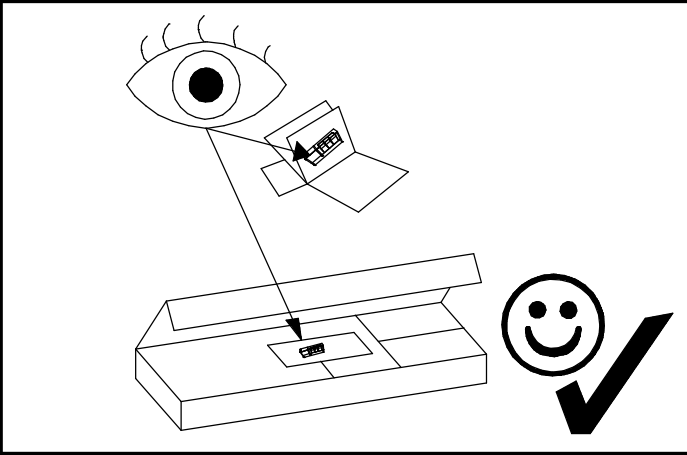
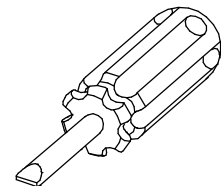
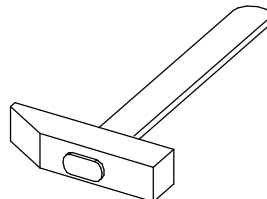
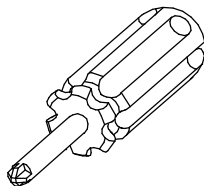
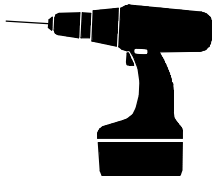
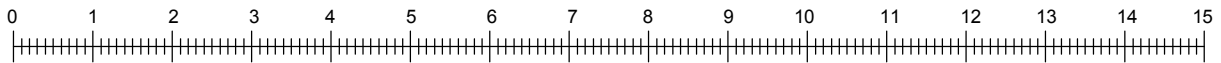
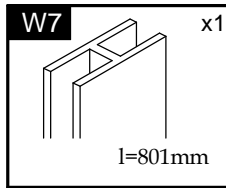
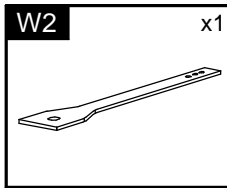
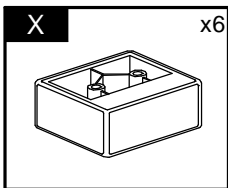
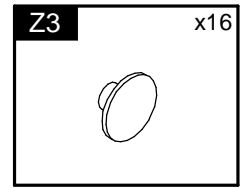
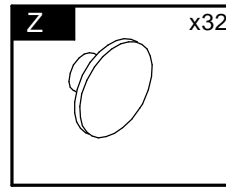
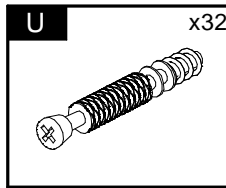
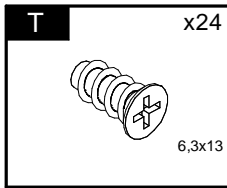
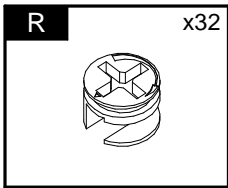
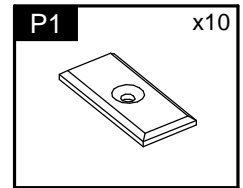
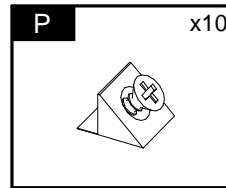
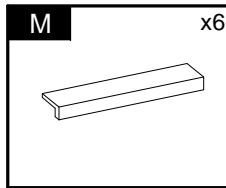
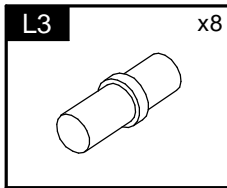
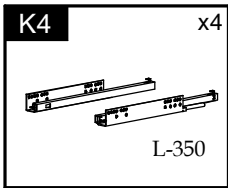
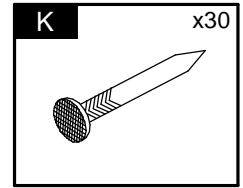
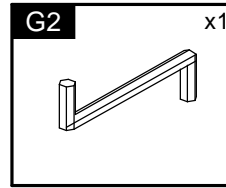
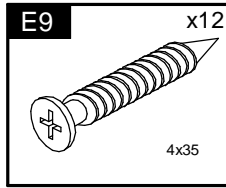
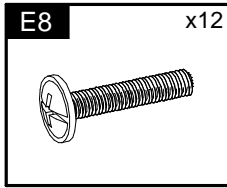
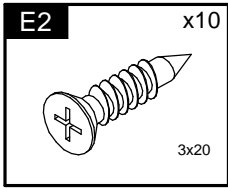
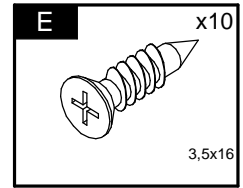
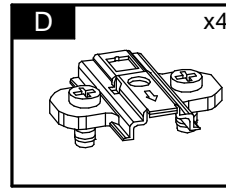
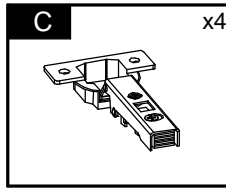
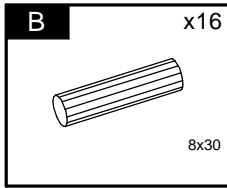
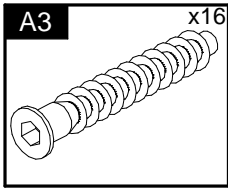

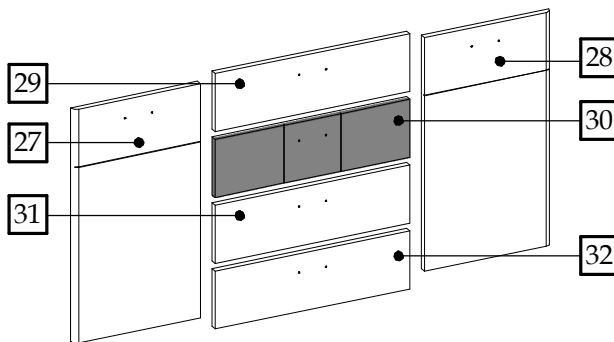
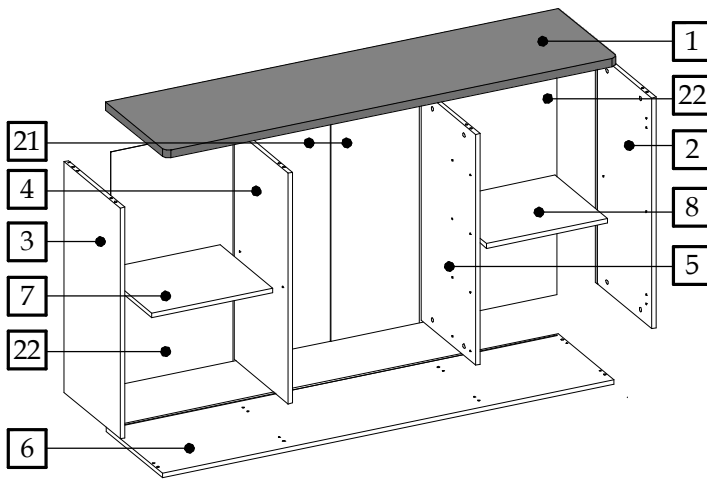
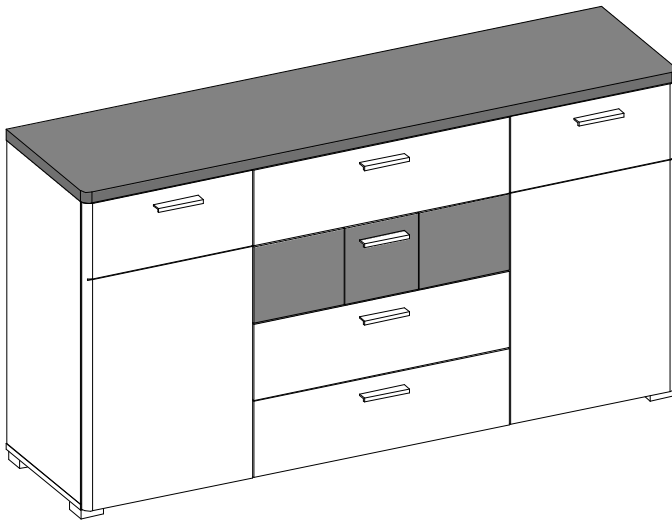

Element symbol	Measurements				Code	Paket
	1	2	3	4		
1	1602	420	22	1	1004	1/2
2	802	395.5	16	1	1001	1/2
3	802	395.5	16	1	1002	1/2
4	802	382.5	16	1	1006	1/2
5	802	382.5	16	1	1007	1/2
6	1600	396	16	1	1003	1/2
7	429.5	373	16	1	N/A	1/2
8	429.5	373	16	1	N/A	1/2
9	633	106.5	16	1	1012	2/2
10	633	106.5	16	1	1027	2/2
11	633	106.5	16	1	1022	2/2
12	633	106.5	16	1	1017	2/2
13	340	120	16	1	1026	1/2
14	340	120	16	1	1016	1/2
15	340	120	16	1	1021	1/2
16	340	120	16	1	1011	1/2
17	340	120	16	1	1023	1/2
18	340	120	16	1	1028	1/2
19	340	120	16	1	1013	1/2
20	340	120	16	1	1018	1/2
21	816	344	2.5	2	N/A	2/2
22	816	444	2.5	2	N/A	2/2
23	642	345	2.5	1	N/A	2/2
24	642	345	2.5	1	N/A	2/2
25	642	345	2.5	1	N/A	2/2
26	642	345	2.5	1	N/A	2/2
27	814	451	22	1	3009_bhx	2/2
28	814	451	22	1	3031_bhx	2/2
29	689	202	22	1	3010_bhx	2/2
30	689	202	22	1	3015_bhx	2/2
31	689	202	22	1	3020_bhx	2/2
32	689	202	22	1	3025_bhx	2/2

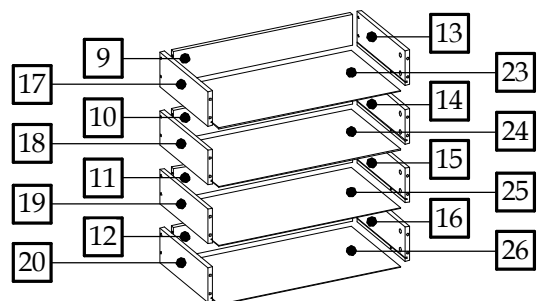

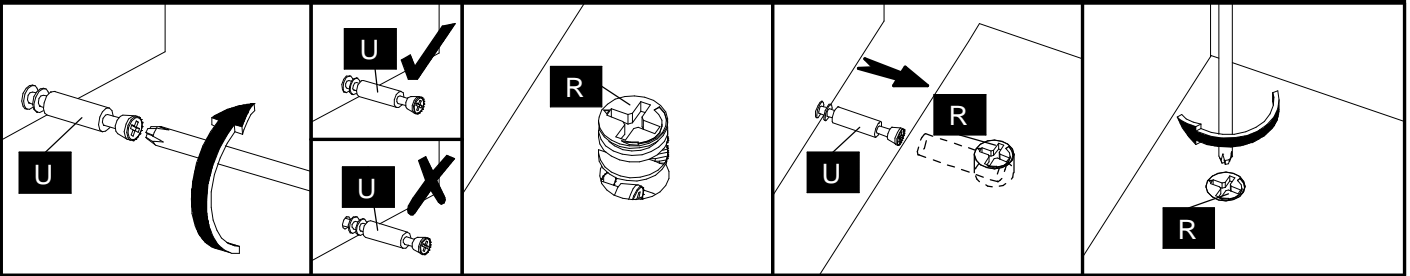

**1**

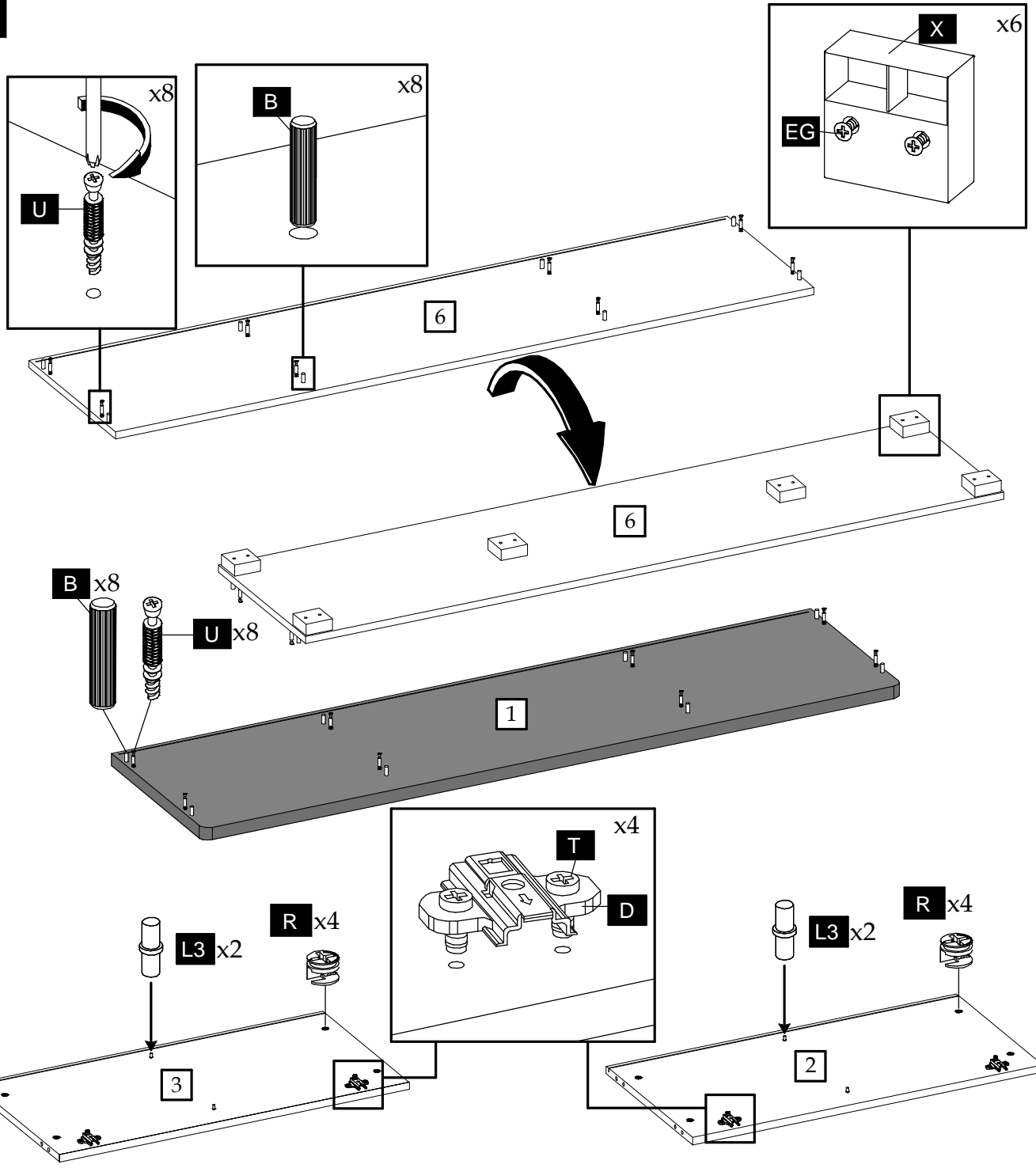

2

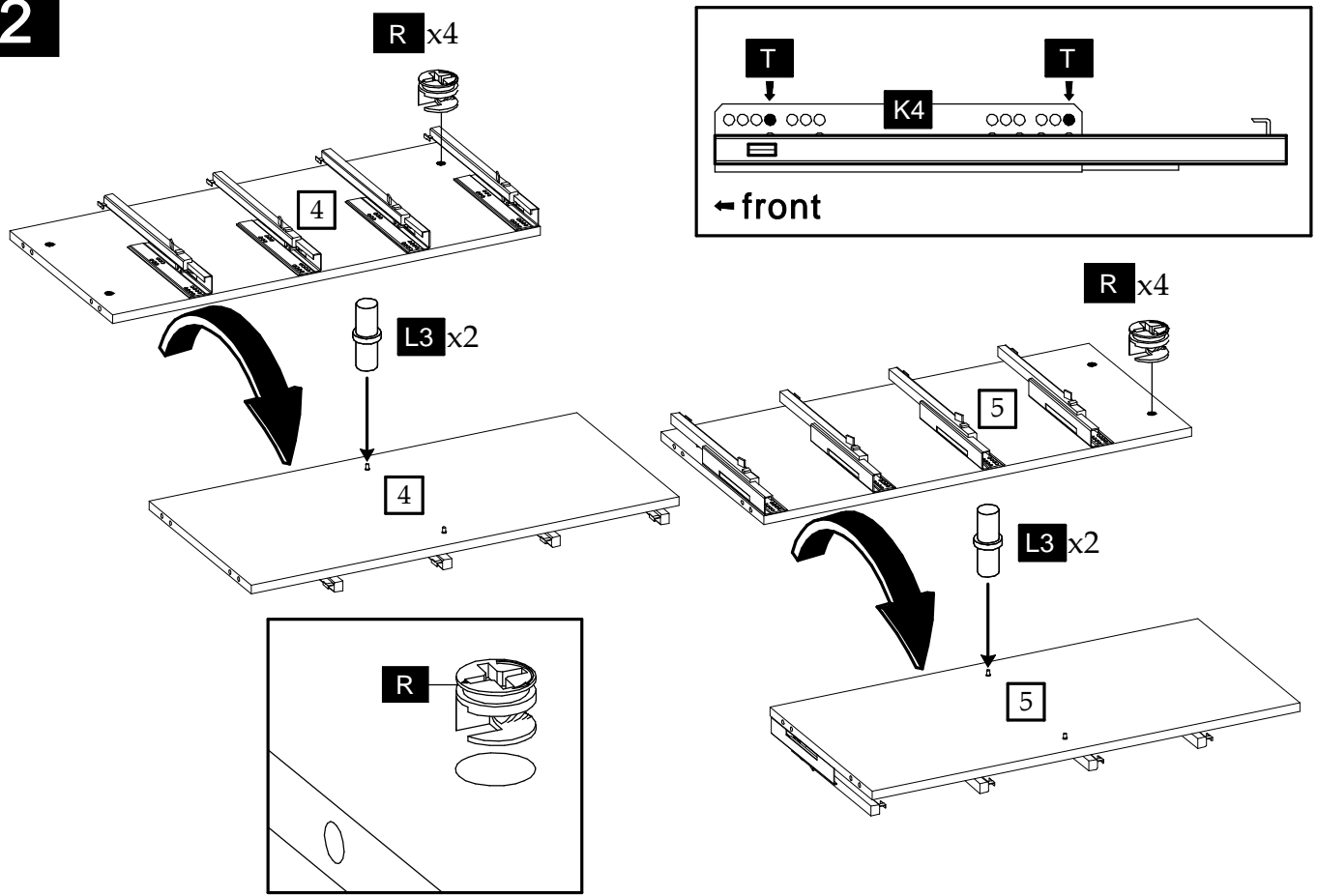

3

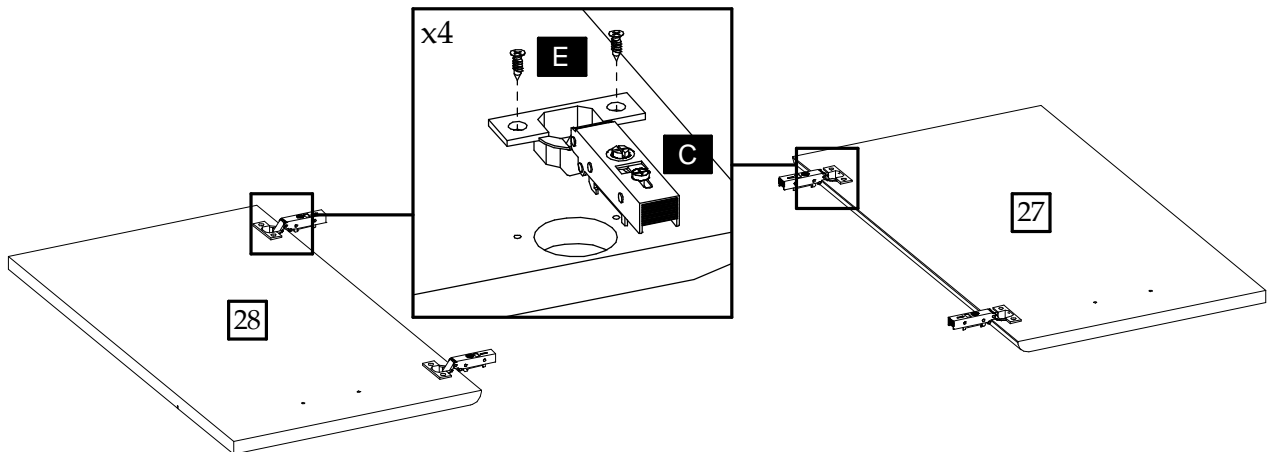

4

R x2

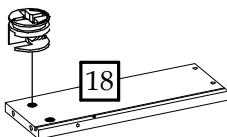

R x2

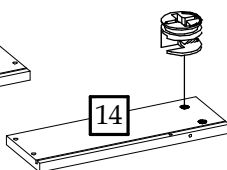

U x4

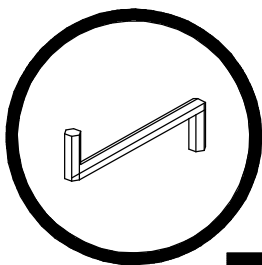
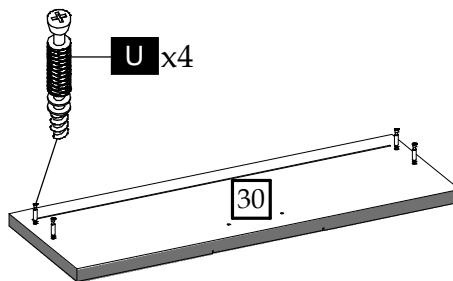

A3

A3

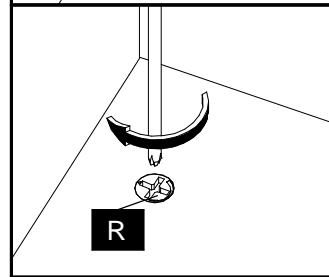
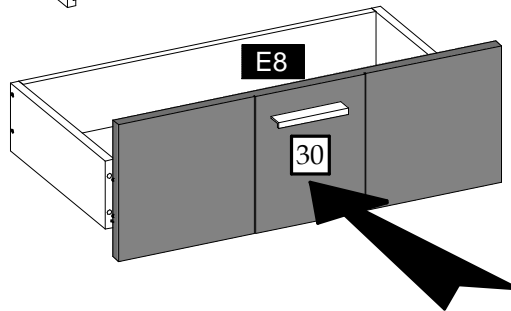
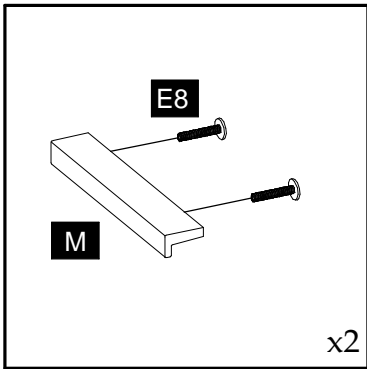
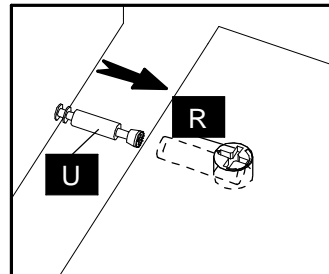
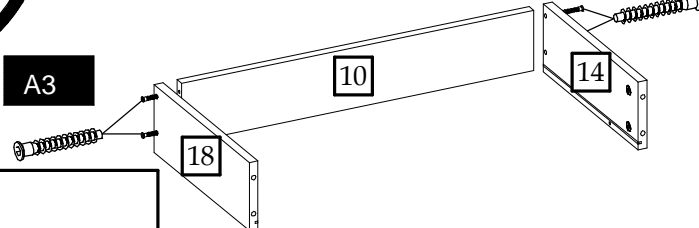

5

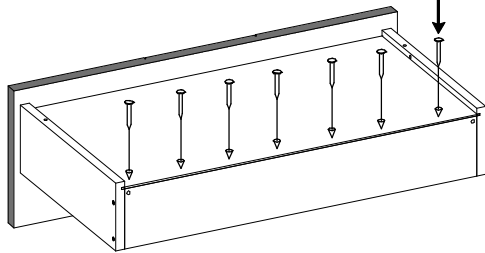
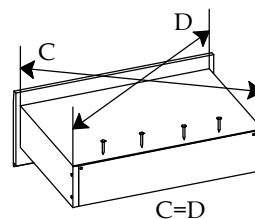
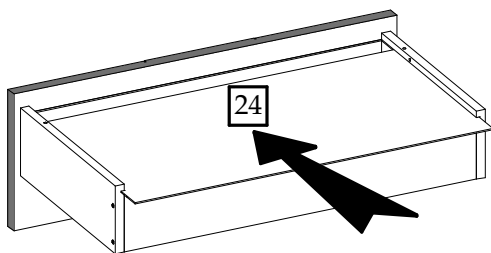

6

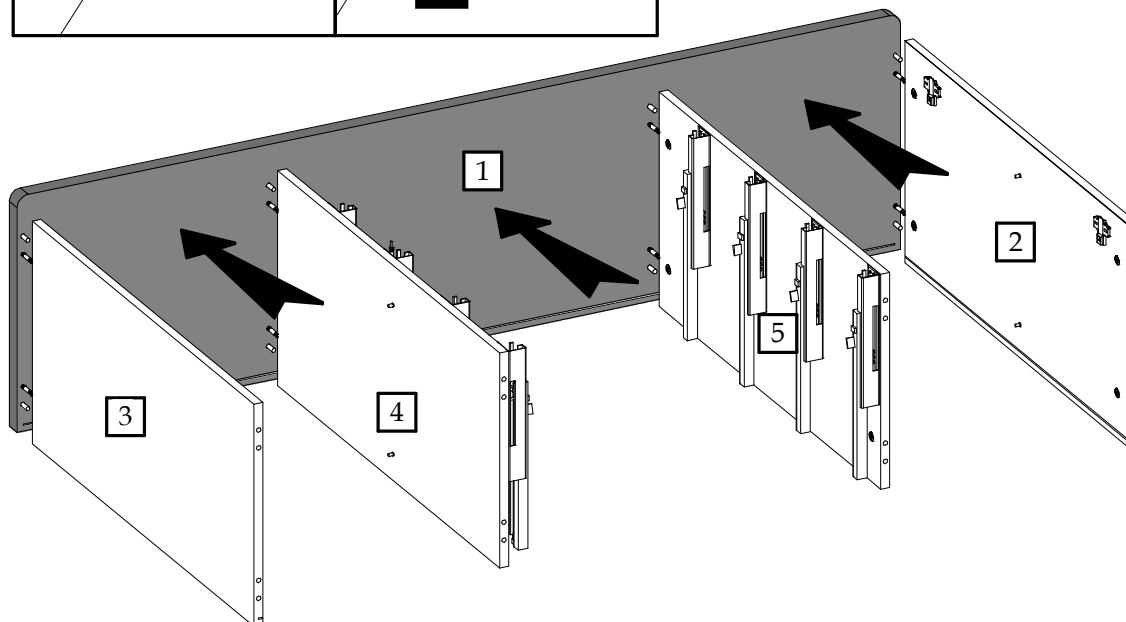
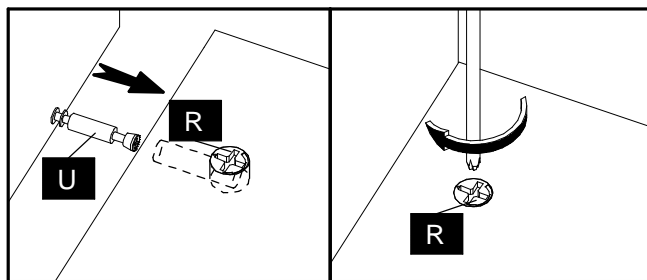

7

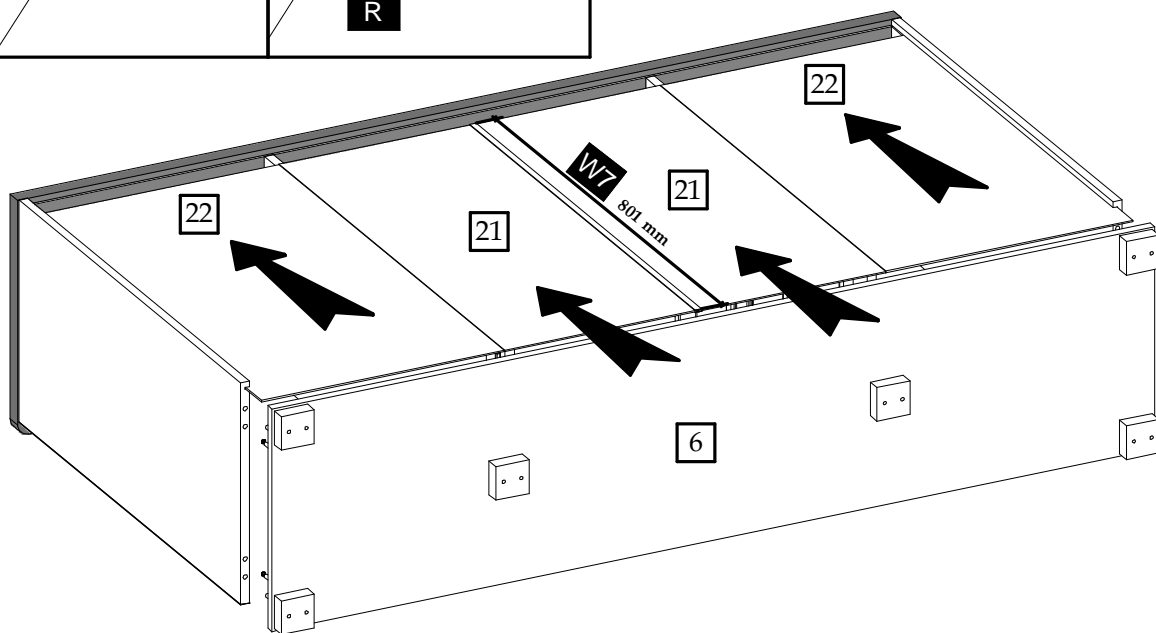
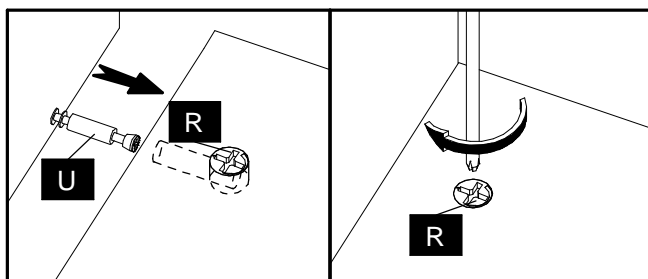

8



